

RGH24 RGS20 linear encoder system



Contents

Product compliance	1
Storage and handling	2
RGH24 readhead installation drawing	3
RGS20 scale installation drawing	4
Scale application	5
End clamps	5
Reference mark and limit switch actuator installation	5
Readhead mounting and alignment	6
Reference mark set-up	6
Limit switch	6
Output signals	7
Speed	7
Electrical connections	8
Output specifications	9
General specifications	10
Scale specifications	10

Product compliance



Renishaw plc declares that RGH24 complies with the applicable standards and regulations. A copy of the EU Declaration of Conformity is available from our website at www.renishaw.com/productcompliance.

FCC compliance

This device complies with part 15 of the FCC Rules. Operation is subject to the following two conditions: (1) This device may not cause harmful interference, and (2) this device must accept any interference received, including interference that may cause undesired operation.

The user is cautioned that any changes or modifications not expressly approved by Renishaw plc or authorised representative could void the user's authority to operate the equipment.

This equipment has been tested and found to comply with the limits for a Class A digital device, pursuant to part 15 of the FCC Rules. These limits are designed to provide reasonable protection against harmful interference when the equipment is operated in a commercial environment. This equipment generates, uses, and can radiate radio frequency energy and, if not installed and used in accordance with the instruction manual, may cause harmful interference to radio communications. Operation of this equipment in a residential area is likely to cause harmful interference in which case the user will be required to correct the interference at his own expense.

NOTE: This unit was tested with shielded cables on the peripheral devices. Shielded cables must be used with the unit to ensure compliance.

Further information

Further information relating to the RGH24 encoder range can be found in the *RGH24 encoder system* Data sheet (Renishaw part no. L-9517-9677). This can be downloaded from our website at www.renishaw.com/opticalencoders and is also available from your local Renishaw representative. This document may not be copied or reproduced in whole or in part, or transferred to any other media or language, by any means without the written prior permission of Renishaw. The publication of material within this document does not imply freedom from the patent rights of Renishaw plc.

Disclaimer

RENISHAW HAS MADE CONSIDERABLE EFFORTS TO ENSURE THE CONTENT OF THIS DOCUMENT IS CORRECT AT THE DATE OF PUBLICATION BUT MAKES NO WARRANTIES OR REPRESENTATIONS REGARDING THE CONTENT. RENISHAW EXCLUDES LIABILITY, HOWSOEVER ARISING, FOR ANY INACCURACIES IN THIS DOCUMENT.

The packaging of our products contains the following materials and can be recycled.

Packaging Component	Material	ISO 11469	Recycling Guidance
Outer box	Cardboard	Not applicable	Recyclable
	Polypropylene	PP	Recyclable
Inserts	Low Density Polyethylene Foam	LDPE	Recyclable
	Cardboard	Not applicable	Recyclable
Bags	High Density Polyethylene Bag	HDPE	Recyclable
	Metalised Polyethylene	PE	Recyclable

REACH regulation

Information required by Article 33(1) of Regulation (EC) No. 1907/2006 ("REACH") relating to products containing substances of very high concern (SVHCs) is available at www.renishaw.com/REACH.



The use of this symbol on Renishaw products and/or accompanying documentation indicates that the product should not be mixed with general household waste upon disposal. It is the responsibility of the end user to dispose of this product at a designated collection point for waste electrical and electronic equipment (WEEE) to enable reuse or recycling. Correct disposal of this product will help to save valuable resources and prevent potential negative effects on the environment. For more information, please contact your local waste disposal service or Renishaw distributor.

Storage and handling

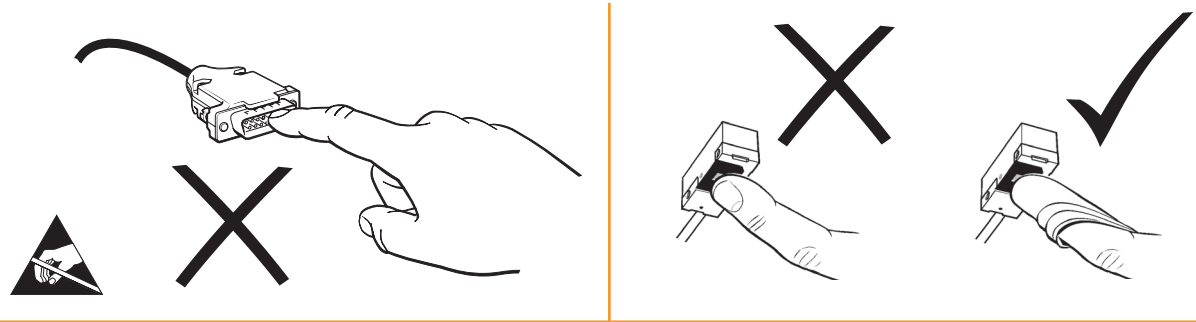
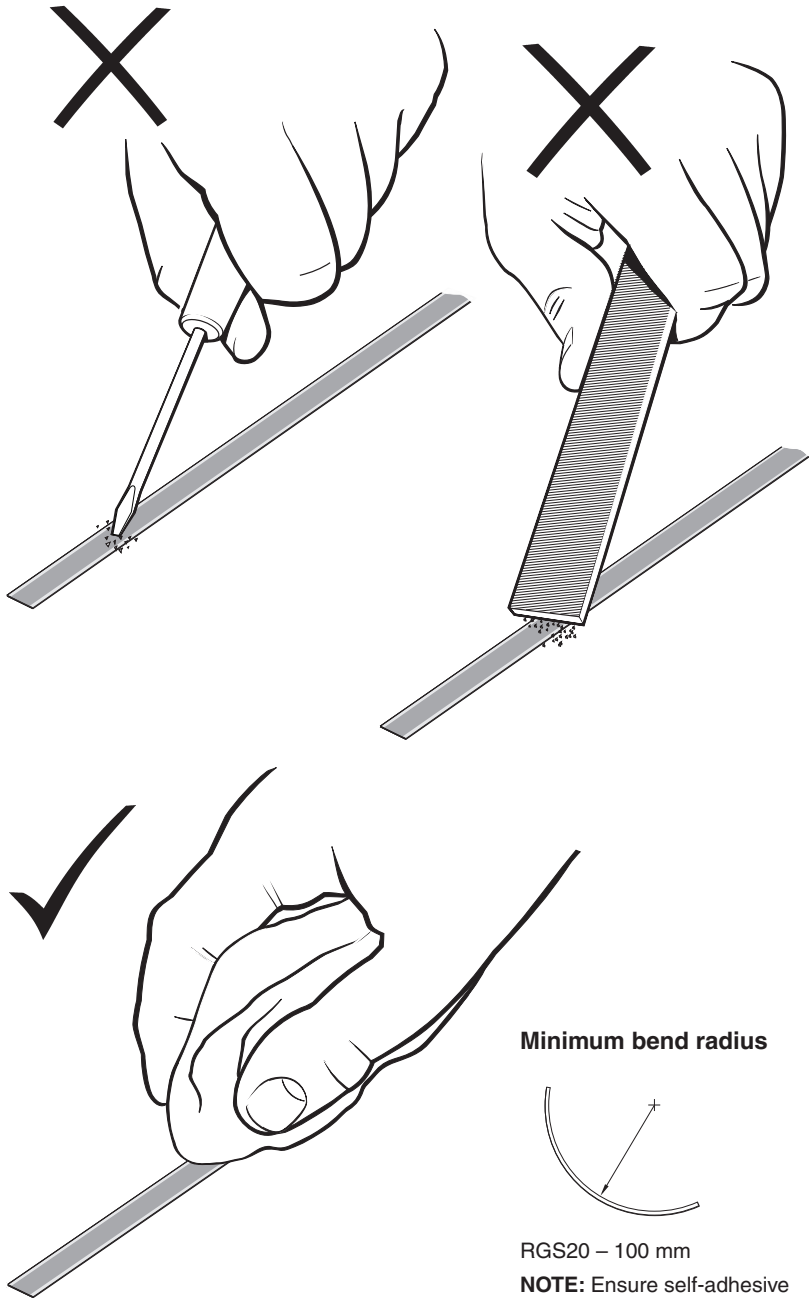

N-heptane

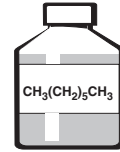

Propan-2-ol

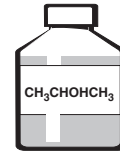

Acetone

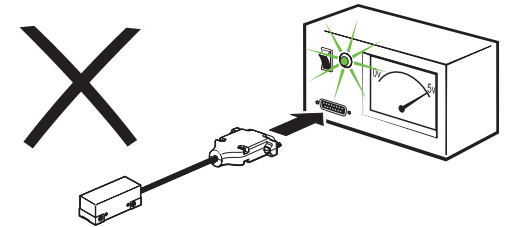
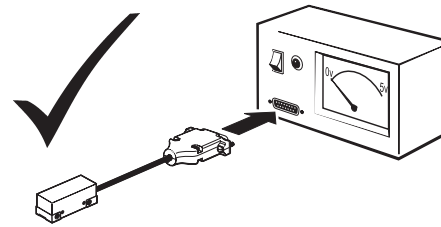
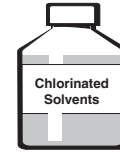
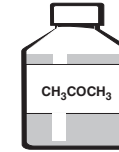

Storage

System
+70 °C
-20 °C

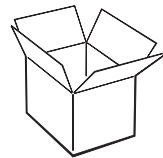

Operating

System
+55 °C
0 °C

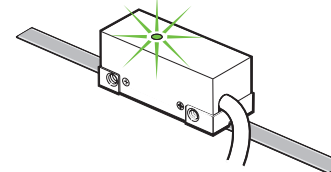

Humidity

95% relative humidity
(non-condensing)
to BS EN 60068-2-78:2013

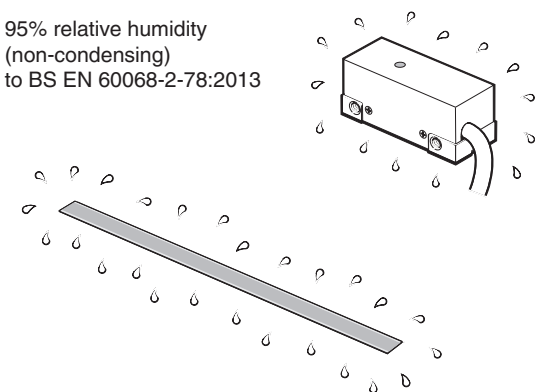

RGH24 readhead installation drawing

Dimensions and tolerances in mm

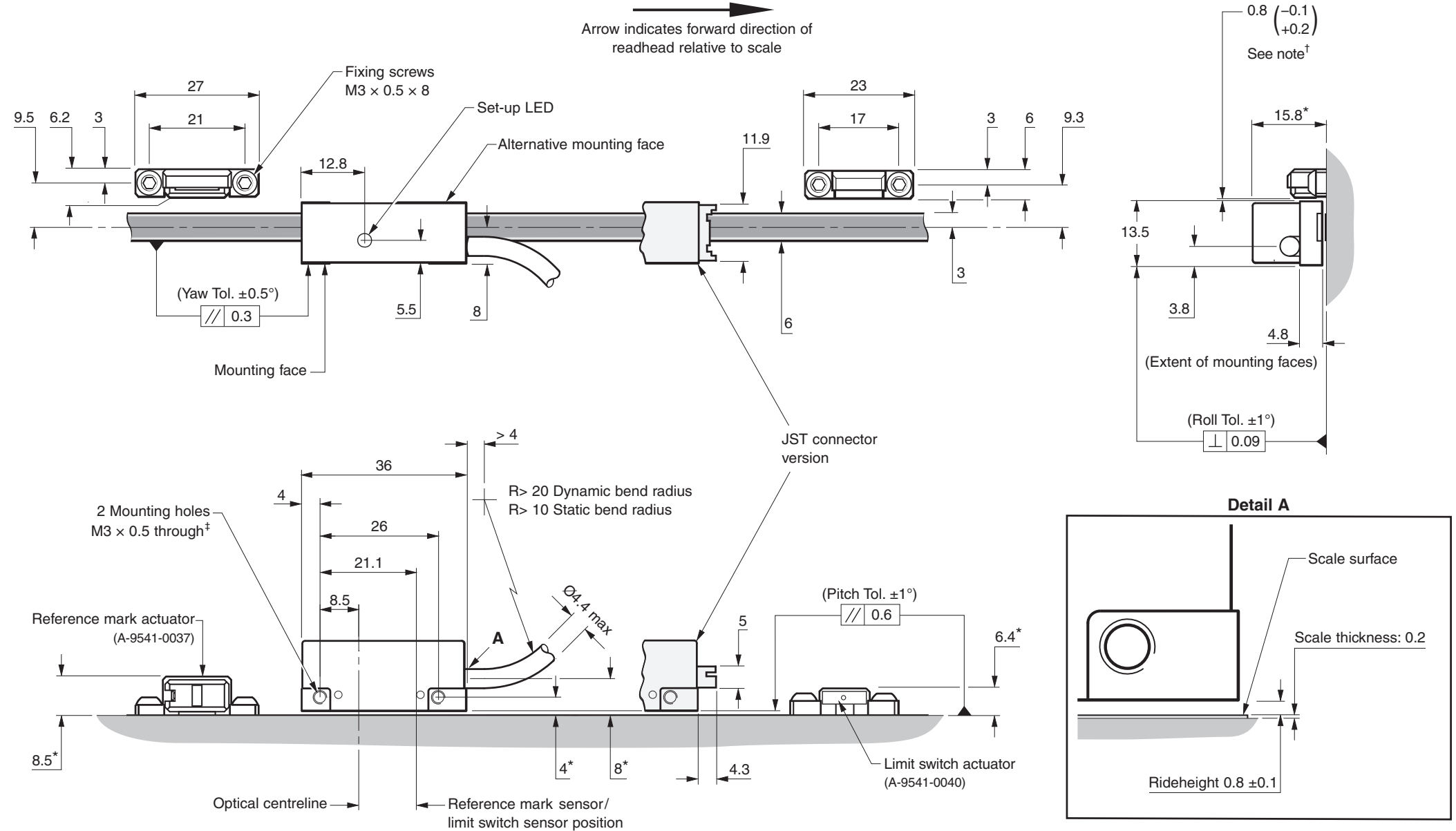

*Dimensions measured from substrate.

†Required nominal 0.8 gap can be set using blue readhead spacer (supplied) positioned between readhead and actuator when positioning/fixing the actuator.

‡The recommended thread engagement is 5 mm. The recommended tightening torque is between 0.5 and 0.7 Nm.

RGS20 scale installation drawing (with reference mark actuator)

Dimensions and tolerances in mm



Bolted reference mark actuator shown
(A-9541-0037)

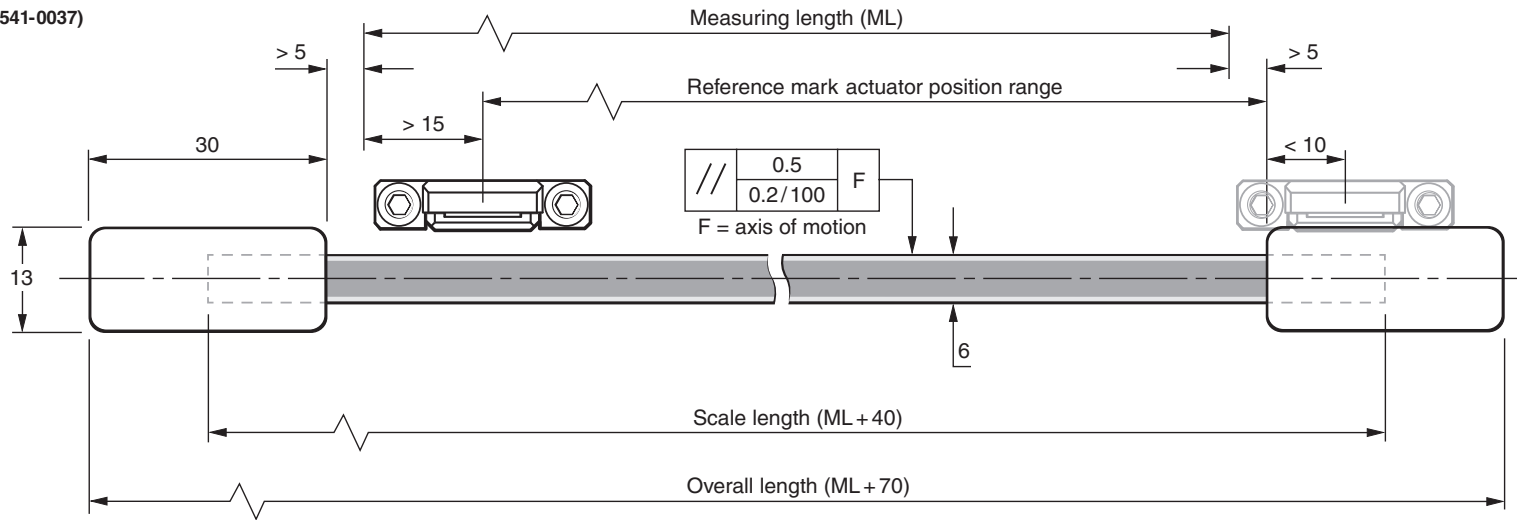

Optional epoxy mounted reference mark actuator
(A-9531-0250)

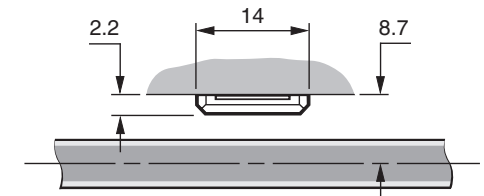

RGS20 scale installation drawing (with limit switch actuator)

Dimensions and tolerances in mm



Bolted limit switch actuator shown
(A-9541-0040)

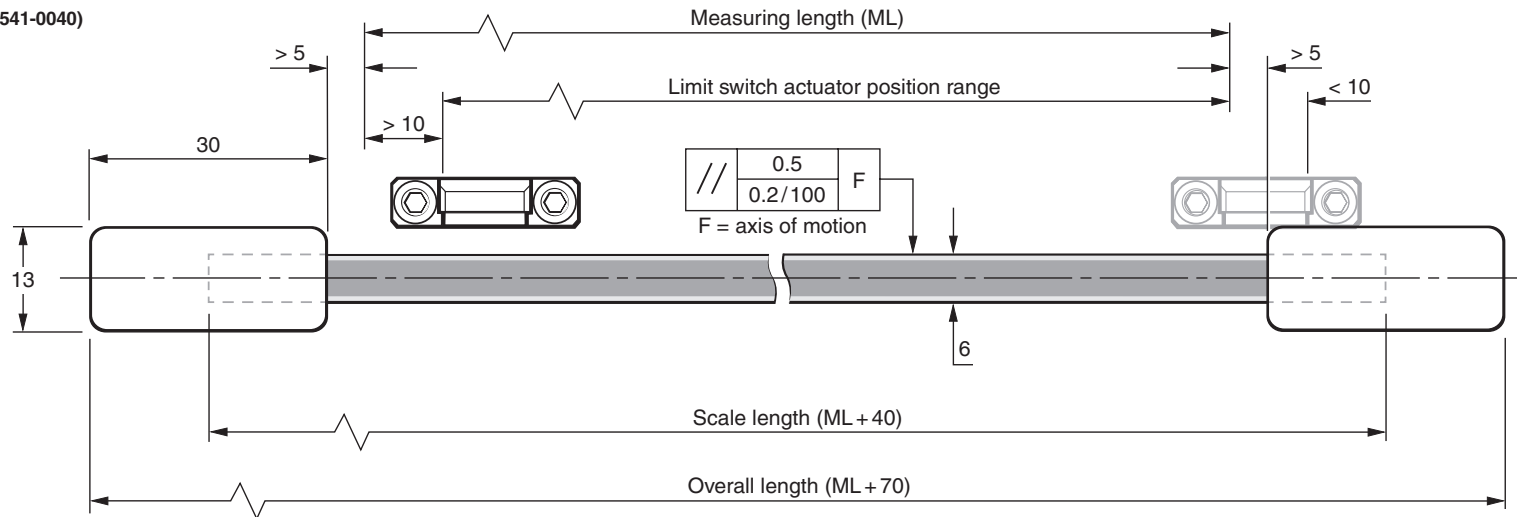

Optional epoxy mounted limit switch actuator
(A-9531-0251)

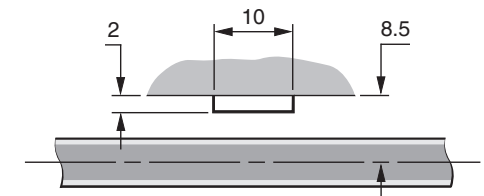

NOTE: The surface roughness of the scale mounting surface must be ≤ 3.2 Ra. The parallelism of the scale surface to the axis of motion (readhead rideheight variation) must be within 0.05 mm.

Scale application

The scale applicator A-9541-0124 is designed specifically for use with the RG24 readheads and RGS20-S scale.

- 1 Allow scale to acclimatize to installation environment prior to installation.
- 2 Thoroughly clean and degrease the substrate using recommended solvents (see 'Storage and handling'). Allow substrate to dry before applying scale.
- 3 Mark out 'START' and 'FINISH' points for the scale on the axis substrate. Ensure that there is room for the end clamps (see 'RGS20 scale installation drawing').
- 4 Mount the appropriate scale applicator to the readhead mounting bracket using M2.5 screws. Place the shim supplied with the readhead between the applicator and substrate to set the nominal height.

NOTE: Scale applicator can be mounted either way round to enable easiest orientation for scale installation.
- 5 Move axis close to scale start position, leaving enough room for the scale to be inserted through the applicator as shown below.
- 6 Begin to remove the backing paper from the scale and insert scale into the applicator up to the 'START' point (as shown). Ensure backing tape is routed under the splitter screw.
- 7 Apply finger pressure to the scale at the 'START' point, using a clean lint-free cloth, to ensure scale end adheres well to substrate.

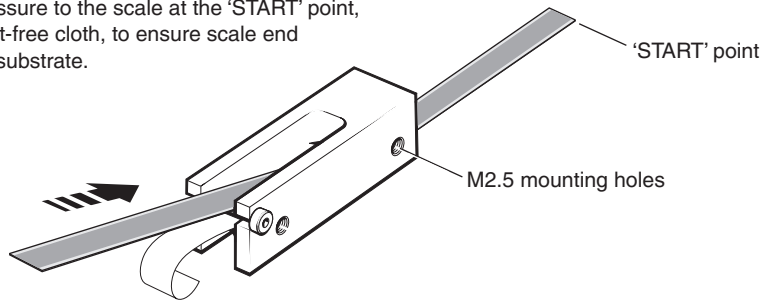

- 8 Slowly and smoothly move the applicator through the entire axis of travel, ensuring the backing paper is pulled manually from the scale and does not catch under the applicator.

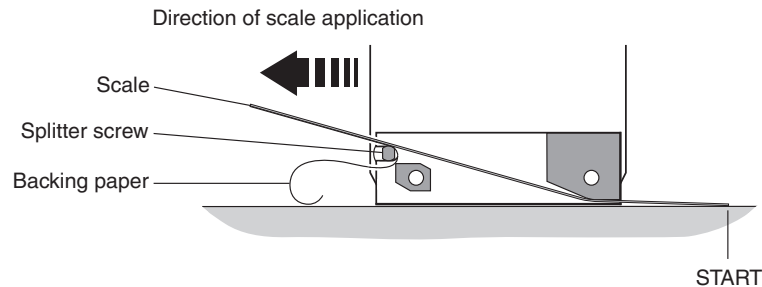

- 9 Remove applicator and, if necessary, adhere remaining scale manually. Apply firm finger pressure via a clean lint-free cloth along the length of the scale after application to ensure complete adhesion.
- 10 Clean the scale using Renishaw scale wipes (A-9523-4040) or a clean, dry, lint-free cloth.
- 11 Fit end clamps (see 'End clamps' section).
- 12 Allow 24 hours for complete adhesion of scale before fitting the reference mark or limit magnet.

End clamps

A-9523-4015 is an end clamp kit designed to be used with Renishaw RGS scale.

IMPORTANT: End clamps should be used to ensure positional stability of the scale and reference mark repeatability.

NOTE: End clamps can be mounted before or after readhead installation.

- 1 Remove the lacquer coating from the last 15 mm of each end of the scale with a knife and clean with one of the recommended solvents (see 'Storage and handling').
- 2 Thoroughly mix up a sachet of glue (A-9531-0342) and apply a small amount to the underside of the end clamp.

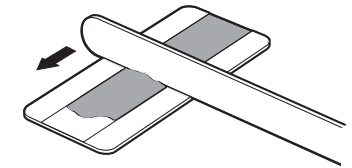
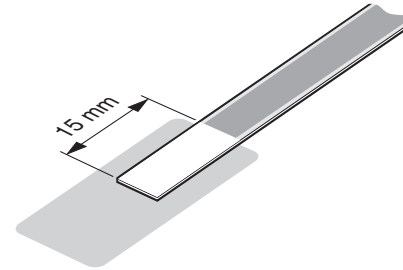

- 3 The end clamp features two small regions of contact adhesive. These will temporarily hold the end clamp in position while the glue cures. Remove the backing tape from either side.
- 4 Immediately position end clamp over the end of the scale. Allow 24 hours at 20 °C for full cure.

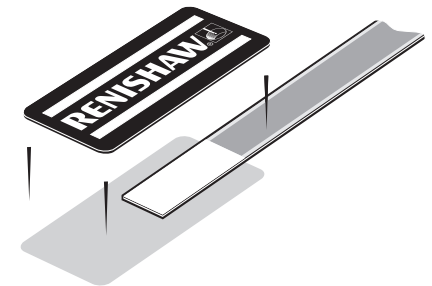
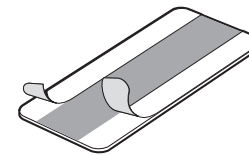

! Ensure that excess glue is wiped away from scale as it may affect the readhead signal level.

Reference mark and limit switch actuator installation

Screw mounted or adhesive mounted reference mark and limit switch actuators are available.

Refer to RG24 readhead installation drawing and RGS20 scale installation drawing for actuator positioning.

Readhead mounting and alignment

Mounting brackets

The bracket must have a flat mounting surface, enable conformance to the installation tolerances, allow adjustment to the rideheight of the readhead, and be sufficiently stiff to prevent deflection or vibration of the readhead during operation. For easier installation, adjust the roll and yaw of the bracket with respect to the axis of readhead travel before the RGH24 is attached. This can be done with a clock gauge and a precision square.

Readhead set-up

To set nominal rideheight, position readhead spacer with 'L' shaped aperture under the optical centre of the readhead to allow normal LED function during set-up procedure. Ensure that the scale, readhead optical window and mounting face are clean and free from obstructions.

NOTE: Ensure readhead fixing screws are tightened to 0.5 Nm-0.7 Nm.

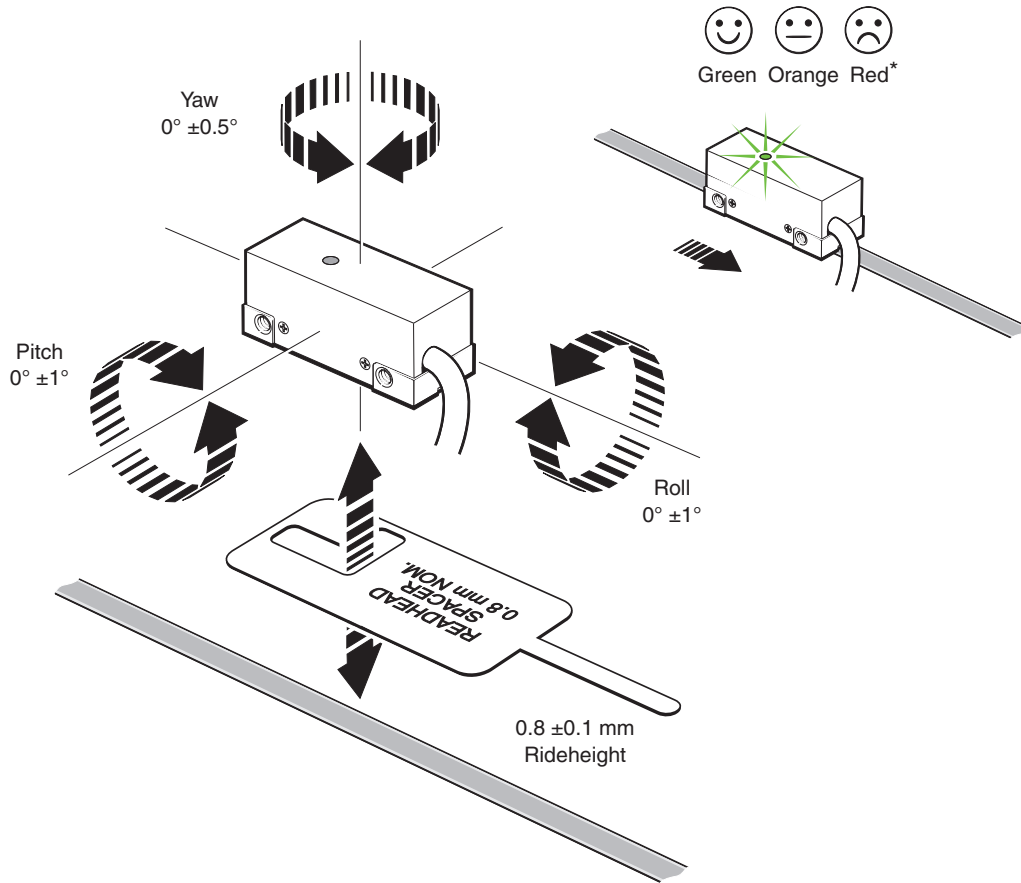

For reliable operation, the set-up LED should be GREEN when readhead is moved along the full axis travel. The JST version of the RGH24 has an LED repeater signal that can be used in cases where the LED is not visible.

*Remote LED will continuously flash Red when signal < 20%

IMPORTANT: The RGH24 range does not incorporate a separate Alarm 'E' signal. Low signal is indicated by a 3-state output of the line driver channels.

Reference mark set-up

To ensure unidirectional repeatability, the reference mark requires phasing with the scale in the direction of normal datuming operation.

A reference pulse is output in both directions, but repeatability is guaranteed only in the phased direction.

Ensure readhead is set up correctly with a green LED indication over the full length of travel and that the reference mark actuator is fitted correctly.

NOTE: It is recommended that a datum procedure is performed as part of any power-up sequence to ensure the correct datum position is recorded.

NOTE: Reference mark output is synchronised with the incremental channels, giving unit of resolution pulse width.

Phasing procedure

The readhead must be moved over the reference mark in the direction to be used for the datuming operation. The reference mark is phased correctly when the set-up LED flashes red for 0.25 seconds. If it flashes orange or goes blank, the reference mark adjuster screw should be turned anti-clockwise by 1/8 turn and the procedure repeated until a red flash is obtained.

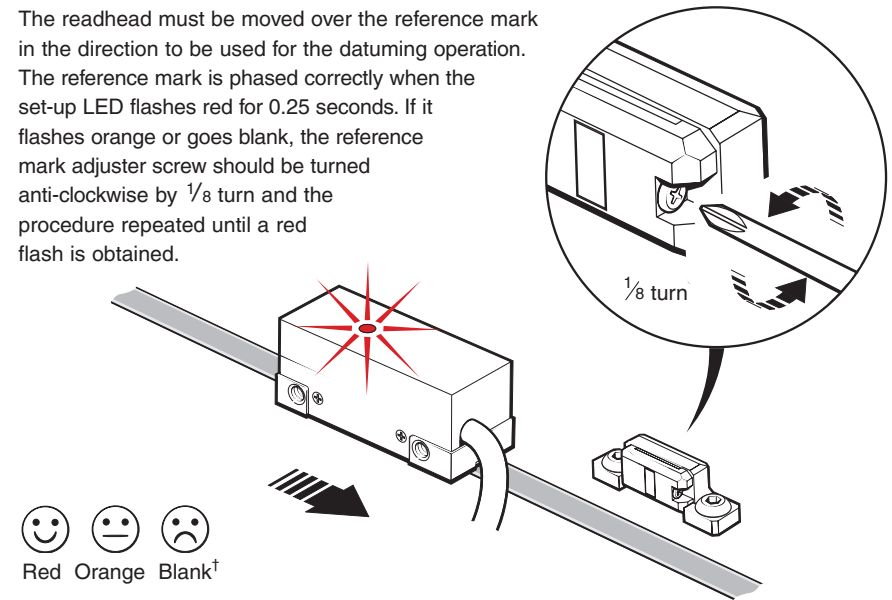

LED flash during reference mark traverse only

†Remote LED will flash Green rather than blank.

Limit switch

A limit switch signal is output when the readhead sensor passes over the magnetic actuator.

NOTE: RGH24 readheads are available with reference mark **or** limit switch detection. Select output at order.

NOTE: Limit switch output is not available with analogue RGH24, or options 60, 61 and 62 of the digital RGH24.

Output signals

RGH24 D, X, Z, W, Y, H, I, O RS422A digital

Function	Signal	Colour	9-way D-type (A)	JST (Z)	15-way D-type (D)
Power	5 V	Brown	5	9	7, 8
	0 V	White	1	10	2, 9
Incremental signals	A	+	2	8	14
		-	6	7	6
	B	+	4	2	13
		-	8	1	5
Reference mark / limit switch	Z+ / Q-	Pink	3	5	12
	Z- / Q+	Grey	7	6	4
Shield	Inner	-	9	N/A	15
	Outer	-	Case	N/A	Case
Remote LED driver	Green	-	N/A	4	N/A
	Red	-	N/A	3	N/A

RGH24B 1Vpp analogue

Function	Signal	Colour	9-way D-type (A)	JST (Z)	15-way D-type (L)
Power	5 V	Brown	5	9	4, 5
	0 V	White	1	10	12, 13
Incremental signals	V ₁	+	2	8	9
		-	6	7	1
	V ₂	+	4	6	10
		-	8	5	2
Reference mark	V ₀	+	3	2	3
		-	7	1	11
Shield	Inner	-	9	N/A	15
	Outer	-	Case	N/A	Case

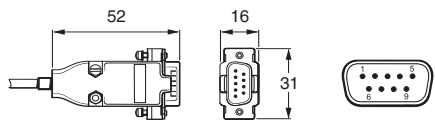

9-way D-type plug (Termination code A)

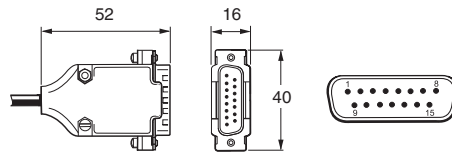

15-way D-type plug (Termination code D, L)

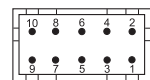

10-way JST plug (Termination code Z)

Speed

Digital readheads

Non-clocked output readheads

Head type	Maximum speed (m/s)	Lowest recommended counter input frequency (MHz)
D (5 μm)	8	$\left(\frac{\text{Encoder velocity (m/s)}}{\text{Resolution (μm)}} \right) \times 4 \text{ safety factor}$
X (1 μm)	5	
Z (0.5 μm)	3	

Clocked output readheads

The RGH24W, Y, H, I and O readheads are available with a variety of different clocked outputs. Customers must ensure they comply with the lowest recommended counter input frequency.

Standard connector options (A, D and F)	JST connector options (Z)	Maximum speed (m/s)					Lowest recommended counter input frequency (MHz)
		Head type					
		W (0.2 μm)	Y (0.1 μm)	H (50 nm)	I (20 nm)	O (10 nm)	
60	-	-	3.0	-	-	-	50
61	-	3.0	1.6	-	-	-	20
62	-	1.3	0.8	-	-	-	10
30	35	-	0.7	0.35	0.13	0.065	12
31	36	-	0.5	0.25	0.09	0.045	8
32	37	0.7	-	-	-	-	6
33	38	0.5	0.25	0.12	0.04	0.02	4

NOTE: Maximum speeds of clocked output variants assume 3 m maximum cable length and minimum 5 V supply at readhead connector.

Analogue readheads

RGH24B - 4 m/s (-3dB)

Electrical connections

Grounding and shielding

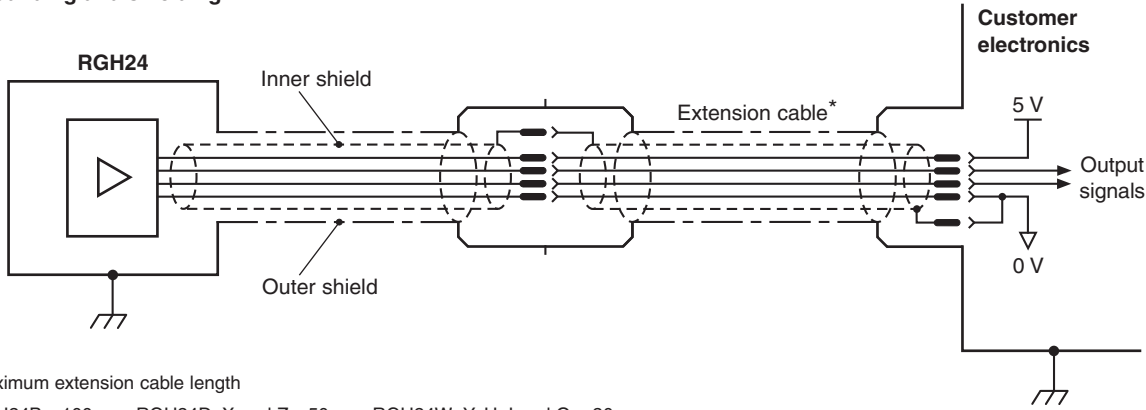

*Maximum extension cable length

RGH24B - 100 m, RGH24D, X and Z - 50 m, RGH24W, Y, H, I and O - 20 m

IMPORTANT: The outer shield should be connected to the machine earth (Field Ground). The inner shield should be connected to 0 V. Care should be taken to ensure that the inner and outer shields are insulated from each other. If the inner and outer shields are connected together, this will cause a short between 0 V and earth, which could cause electrical noise issues.

Recommended signal termination

Digital outputs - RGH24D, X, Z, W, Y, H, I and O

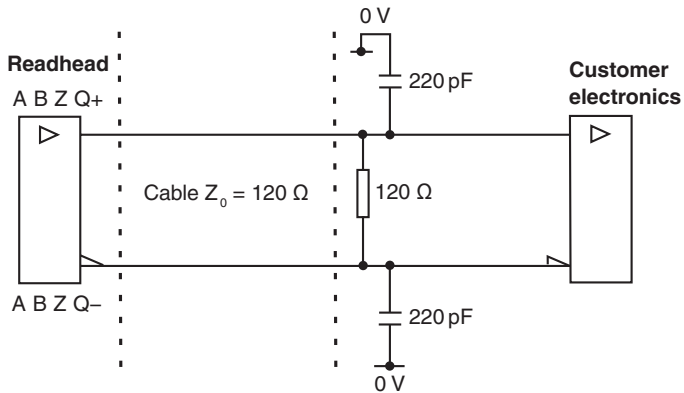

Standard RS422A line receiver circuitry

Capacitors recommended for improved noise immunity.

Analogue output - RGH24B

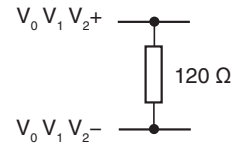

Remote LED driver outputs

JST connector version allows for remote monitoring of readhead status.

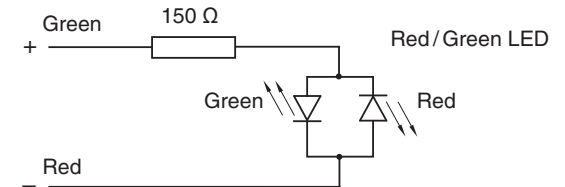

Output specifications

Digital output signals - type RGH24D, X, Z, W, Y, H, I and O

Form - Square wave differential line driver to EIA RS422A

Incremental[†] 2 channels A and B in quadrature (90° phase shifted)

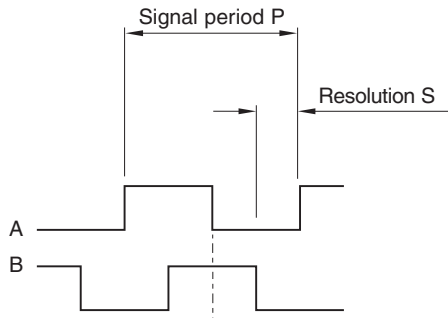

Model	P (μm)	S (μm)
RGH24D	20	5
RGH24X	4	1
RGH24Z	2	0.5
RGH24W	0.8	0.2
RGH24Y	0.4	0.1
RGH24H	0.2	0.05
RGH24I	0.08	0.02
RGH24O	0.04	0.01

Reference

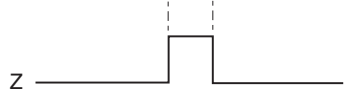

Synchronised pulse Z, duration equal to the resolution.
Repeatability of position (uni-directional) maintained within $\pm 10^\circ\text{C}$ from installation temperature and for speed $< 250\text{ mm/s}$.

Actuation device: A-9541-0037 or A-9531-0250

Limit

Asynchronous pulse

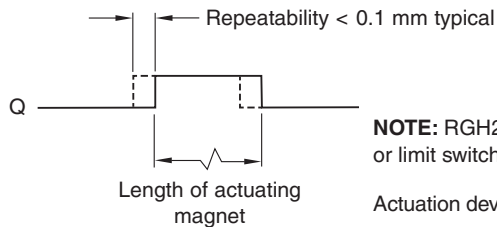

NOTE: RGH24 readheads are available with reference mark or limit switch detection. Select output at order.

Actuation device: A-9541-0040 or A-9531-0251

NOTE: Limit output not available for readheads with option 60, 61 and 62.

Alarm

3-state alarm

Incremental channels forced open circuit for $> 20\text{ ms}$ when signal too low for reliable operation.
For RGH24W, Y, H, I and O only, incremental channels forced open circuit for $> 10\text{ ms}$ when signal too low or speed too high for reliable operation.

[†]Inverse signals not shown for clarity

Analogue output signals type RGH24B (1Vpp)

Incremental 2 channels V_1 and V_2 differential sinusoids in quadrature (90° phase shifted)

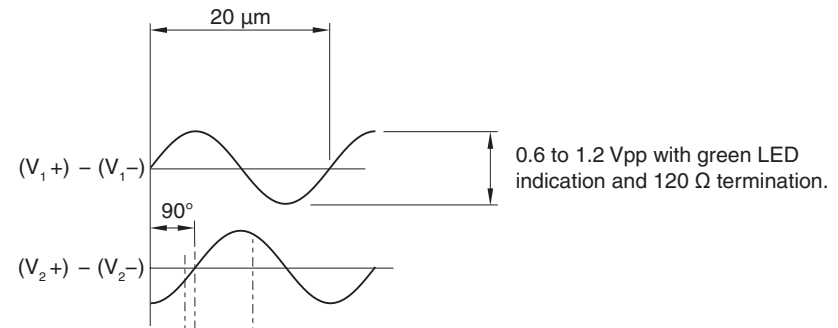

0.6 to 1.2 Vpp with green LED indication and $120\ \Omega$ termination.

Reference

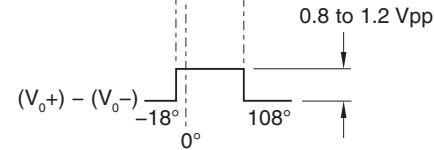

Differential pulse V_0 -18° to 108° .
Duration 126° (electrical).
Repeatability of position (uni-directional) maintained within $\pm 10^\circ\text{C}$ from installation temperature and for speed $< 250\text{ mm/s}$.

Actuation device: A-9531-0037 or A-9531-0250

General specifications

Power supply	5 V \pm 5%	120 mA
	<p>NOTE: Current consumption figures refer to unterminated readheads. For digital outputs a further 25 mA per channel pair (e.g. A+, A-) will be drawn when terminated with 120 Ω. For analogue outputs a further 20 mA will be drawn when terminated with 120 Ω. Power from a 5 V dc supply complying with the requirements for SELV of standard IEC BS EN 60950-1.</p>	
	Ripple	200 mVpp @frequency up to 500 kHz maximum.
Temperature	Storage	-20 °C to +70 °C
	Operating	0 °C to +55 °C
Humidity		95% relative humidity (non condensing) to EN 60068-2-78
Sealing		IP40
Acceleration	Operating	500 m/s ² , 3 axes
Shock	Non-operating	1000 m/s ² , 6 ms, ½ sine, 3 axes
Vibration	Operating	100 m/s ² max @ 55 Hz to 2000 Hz, 3 axes
Mass	Readhead	11 g
	Cable	34 g/m
Cable		8 core, double shield, maximum diameter 4.4 mm Flex life > 20 \times 10 ⁶ cycles at 20 mm bend radius

The RGH24 series readheads have been designed to the relevant EMC standards, but must be correctly integrated to achieve EMC compliance. In particular, attention to shielding arrangements is critical. Renishaw recommends the use of a double screened cable to connect RGH24 JST as used in the cable variants of the RGH24

Scale specifications

Scale type	Reflective gold plated steel tape with protective lacquer coating. Adhesive backing tape allows direct mounting to the machine substrate.	
Scale period	20 μ m	
Linearity	\pm 3 μ m/m	
Scale length	Up to 50 m (> 50 m by special order)	
Form (H \times W)	0.2 mm \times 6 mm (includes adhesive)	
Substrate materials	Metals, ceramics and composites with expansion coefficients between 0 and 22 μ m/m/°C (steel, aluminium, Invar, granite, ceramic etc.)	
Coefficient of thermal expansion	Matches that of substrate material when scale ends are fixed by epoxy mounted end clamps	
End fixing	Epoxy mounted end clamps (A-9523-4015) using 2 part epoxy adhesive (A-9531-0342) Scale end movement typically < 1 μ m up to +40 °C	
Temperature	Operating	-10 °C to +120 °C.
	Minimum installation	10 °C
	Storage	-20 °C to +70 °C.
Humidity	95% relative humidity (non-condensing) to EN 60068-2-78	

Renishaw plc
New Mills, Wotton-under-Edge
Gloucestershire, GL12 8JR
United Kingdom

T +44 (0)1453 524524
F +44 (0)1453 524901
E uk@renishaw.com
www.renishaw.com

RENISHAW 
apply innovation™

For worldwide contact details, visit www.renishaw.com/contact

RENISHAW HAS MADE CONSIDERABLE EFFORTS TO ENSURE THE CONTENT OF THIS DOCUMENT IS CORRECT AT THE DATE OF PUBLICATION BUT MAKES NO WARRANTIES OR REPRESENTATIONS REGARDING THE CONTENT. RENISHAW EXCLUDES LIABILITY, HOWSOEVER ARISING, FOR ANY INACCURACIES IN THIS DOCUMENT.

© 2001-2019 Renishaw plc. All rights reserved.

Renishaw reserves the right to change specifications without notice.

RENISHAW and the probe symbol used in the RENISHAW logo are registered trade marks of Renishaw plc in the United Kingdom and other countries.

apply innovation and names and designations of other Renishaw products and technologies are trade marks of Renishaw plc or its subsidiaries.

All other brand names and product names used in this document are trade names, trade marks or registered trade marks of their respective owners.



M - 9541 - 9109 - 02

Part no.: M-9541-9109-02-B

Issued: 11.2019